

# VI TWO WALL FIXTURE SET

## Notice Utilisateur User Guide

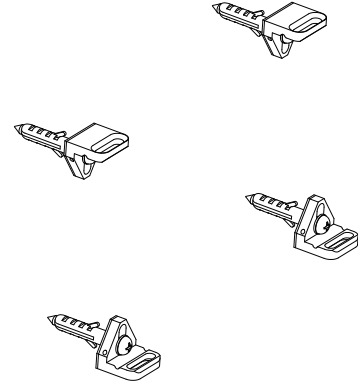

Normes Européennes et Internationales  
European and International Standard



Si vous souhaitez obtenir de l'aide, vous pouvez contacter le Service Après Vente. Avant de contacter VitrineMedia, notez le modèle et le numéro de série du produit. Vous trouverez ces informations directement sur le produit ou sur l'emballage.

*For assistance, please contact our After Sale Service. Before contacting VitrineMedia, please write down the product model and serial number. You can find this information directly on the product or on the packaging.*

Rev. A

VITRINEMEDIA

50 route de la Reine - 92 100 Boulogne-Billancourt - FRANCE | Tel: +33 (0)1 49 21 00 61 | sav@vitrinemedia.com

VITRINEMEDIA

### 2-5

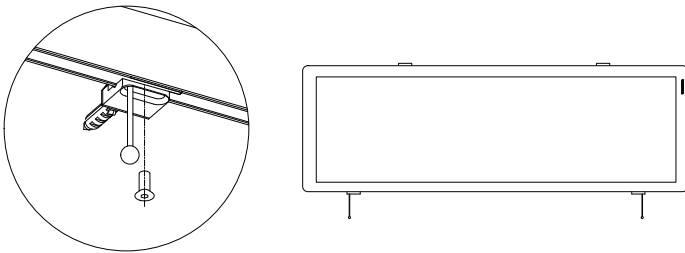

### 2-7

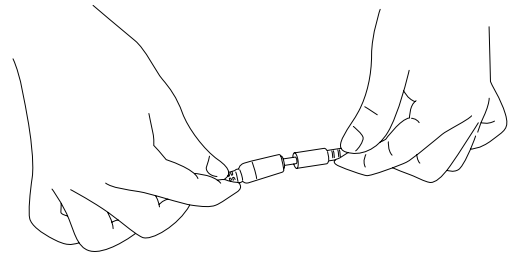

### 2-6 Ajoutez plus d'écrans (acte optionnel). Load more displays (optional action).

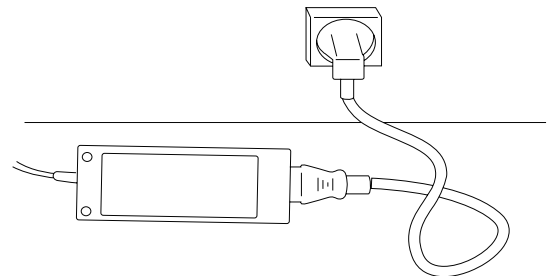
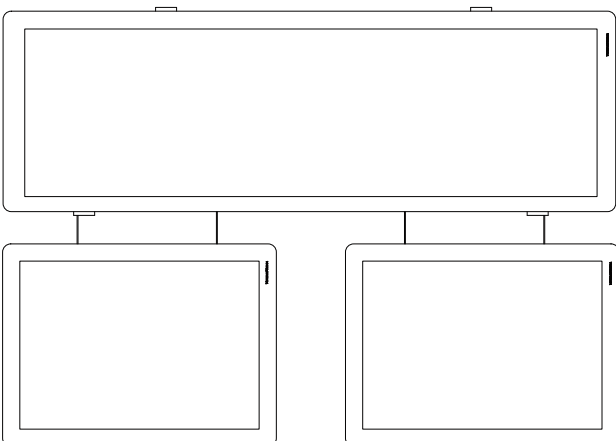

Contenu / Content

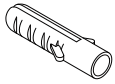

Cheville (x4)  
Dowel (x4)

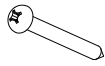

Vis longue (x4)  
Long screw (x4)



Canon de perçage (x4)  
Bushing (x4)



Vis courte (x4)  
Short screw (x4)



Guide de perçage (x2)  
Jig (x2)

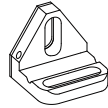

Bride de serrage (x4)  
Clamp (x4)

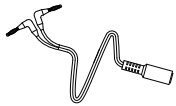

Câble électrique (x1)  
Electrical cable (x1)



Clé allen (x1)  
Allen Key (x1)

**2** Installez.  
Install.

**2-1**

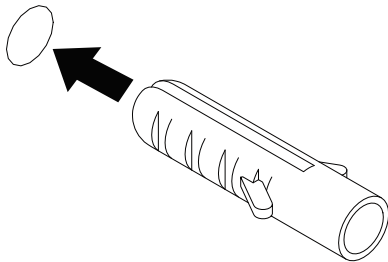

**2-2**

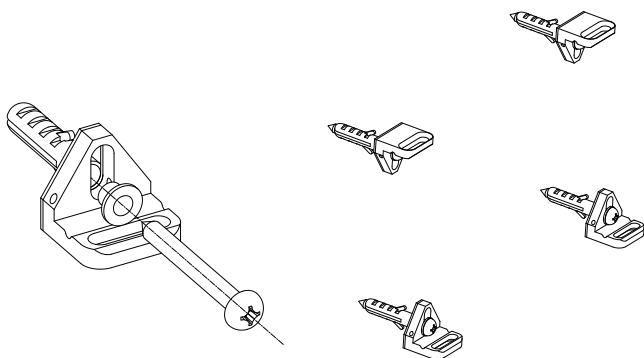

**1** Marquez sur le mur.  
Mark on the wall.

**1-1**

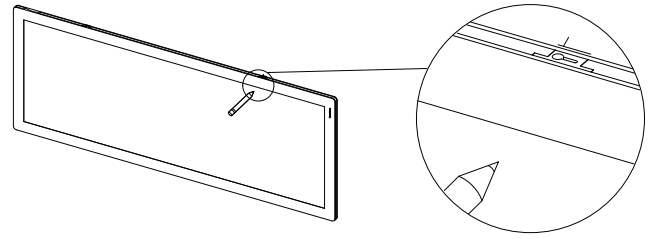

**1-2**

Haut  
Top

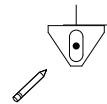

Bas  
Bottom

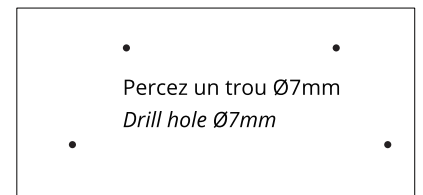

**2-3**

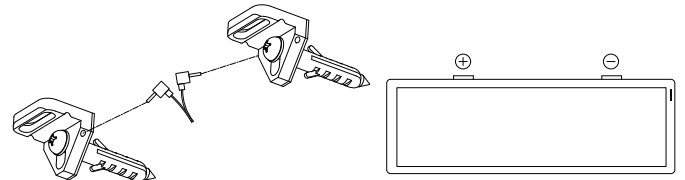

**2-4**

D'abord le haut  
Top first

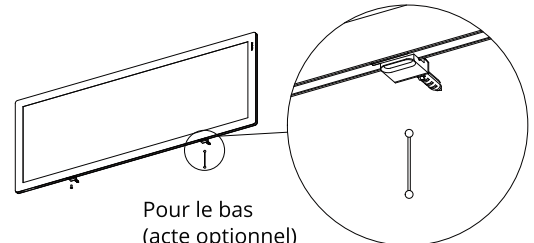
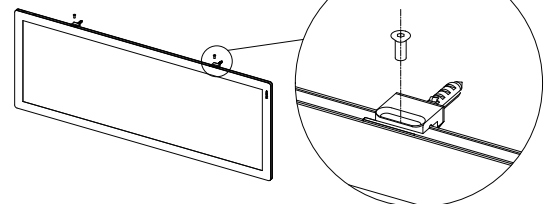

Pour le bas  
(acte optionnel)  
For bottom  
(optional action)

Si besoin de VM TWO en dessous de la bannière.  
If VM TWO needed under the banner.